

Door Access Control with Swing Door Automation System

From
Ishan Systems World
www.ishansystemsworld.com

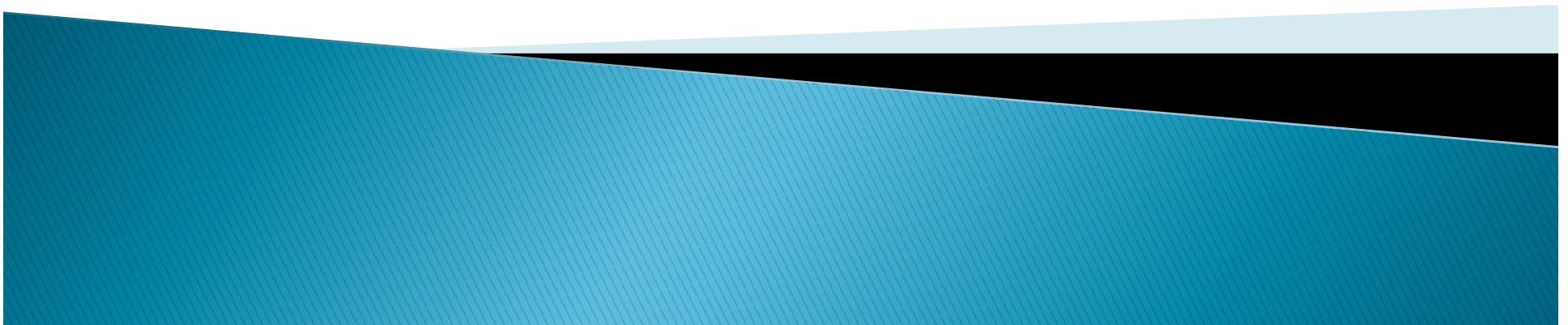

Access Verifications Through



Face



Card



Password



QR

Features



Mask
Detection



Live
Detection



Cloud



WDR



Touch Screen



Wi-Fi



TCP/IP



MultiFace

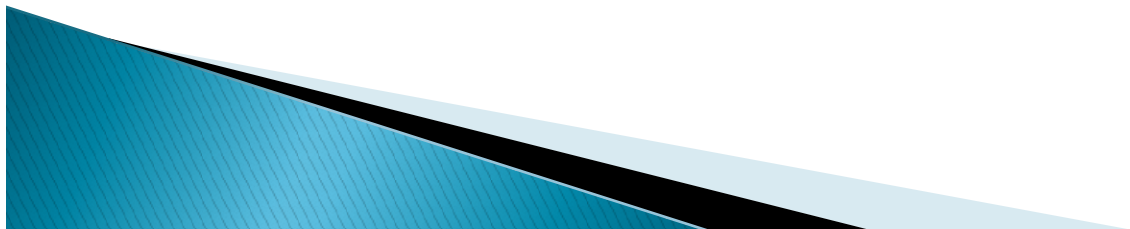

Swing Door (No Push or Pull)

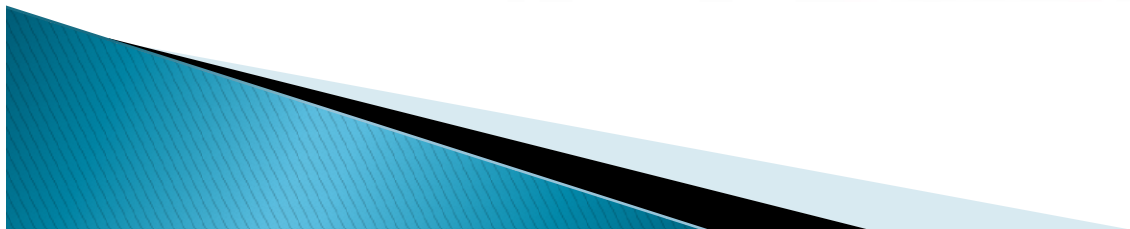

Swing Machine & Accessories

Standard Accessories



Optional Accessories



Door Control Panel

Hand Sensors

Motion Sensors

Electro Magnetic Lock

For Office & Residential Door

SP SWD 200

Applications

- Office
- Residence
- Old Age Home
- Hospitals

Features

AUTO Swing Door Operators are mainly used in commercial & residential building, due to its simplicity and convenience.

It is mainly used in Boss Chamber, where he wants to control the entry door with Remote Control. When the Boss unlock the door, the Door opens automatically by sensing visitor movement through motion sensor and closes automatically.

It is also used in Hospitals for movement of wheel chair and trolleys.

Model	SP SWD 200	SP SWD 200
Door Type	Double	Single
Door Weight	2 x 200 Kg	1 x 200 kg
Door Width	DW=650 —1250mm x 2	DW=650 1250mm
Motor Type	AC 230V/50 Hz	AC 230V / 50 Hz
Opening Time	4 Sec	
Lock Force	300 N	
Hand Push Force	< 40 N	
Program Controller	Micro controller Based to Set Door Parameters	
Standard Accessories	Motor with Door Closer, Wireless Push Switch, Remote Control	
Optional Accessories	Motion Sensor , Hand Scanner, EM Lock, Door Control Panel	

* Specification are subjected to change for improvements

Sensor Door

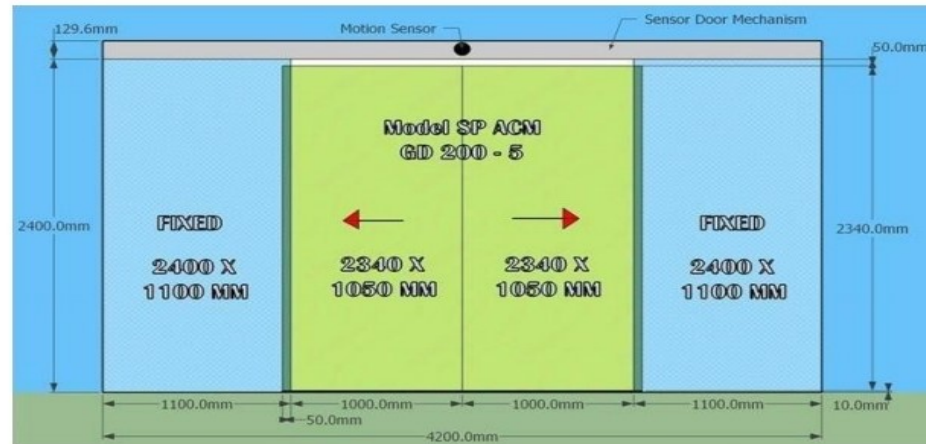

Picture – 1 (Door Layout – front View)

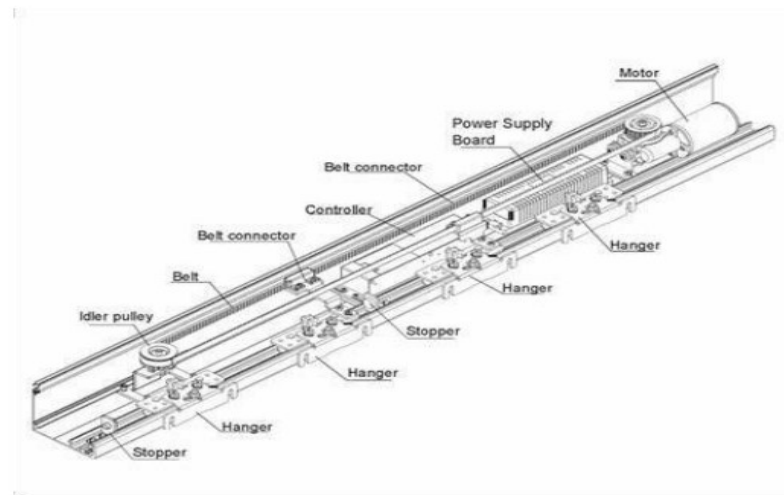

Picture – 2 (Sensor Door Mechanism)

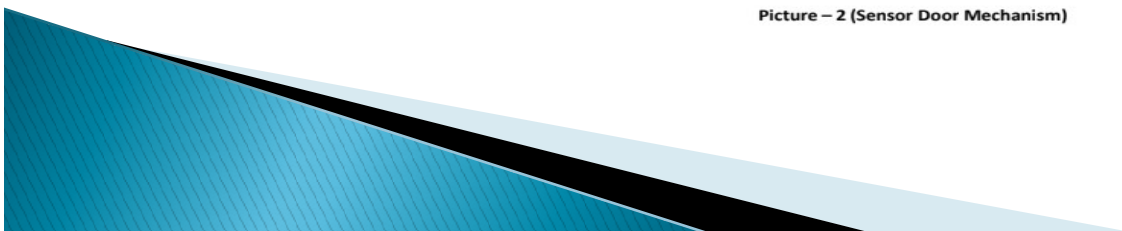

Sensor Door

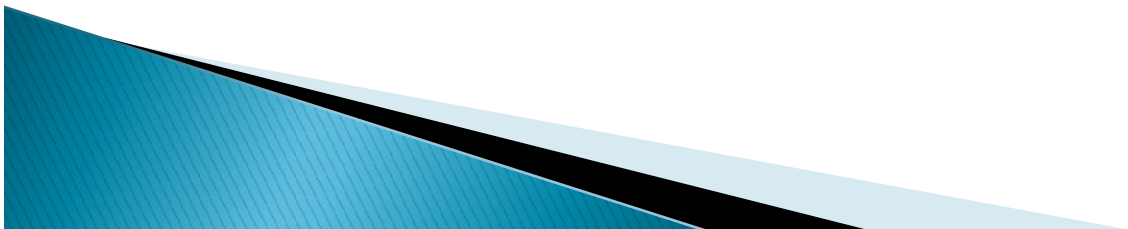

Sensor Door Machine

For Commercial & Industrial purpose
SP GSD 200-5



Standard Accessories



6 Key Remote Switch Motion Sensors X 2 nos Photo Safety Sensors

Optional Accessories



Wireless Push Switch

Applications

- Entrance & Partition Door in Malls
- Office • Airports • Hospitals • Industry
- Colleges • Residence & Clubs etc

Features

- Double Rail Line Technology
- Noise Less Operation
- Heavy Duty 2 x 125 kg door
- Microwave 24Ghz Motion Sensor
- Remote controlled Operation
- Manual Lock not required.
- Elegant Aluminum Cover
- Photo Safety Sensor
- Holes not needed in Glass
- Wider Opening available

Model	SP GSD 200-5	SP GSD 200-5
Door Type	Double	Single
Door Weight	2 x 120 Kg	1 x 150 kg
Door Width (Max Open)	2000 mm	1800 mm
Door Width (Total)	4200 mm	2100 mm
AC Power	SMPS 140 – 280V AC / 50Hz / 1 P / 100 W	
Open-Close Speed	250— 500mm/s	
Opening Time	2 – 10 Sec (Adjustable)	
Motor Type	Heavy Duty 24V DC Brushless Motor	
Program Controller	Micro controller Based to Set Door Parameters	
Standard Accessories	Motion Sensor x 2 , 6 Key Switch,Photo Safety Sensor, Door Hanger, Cover	
Optional Accessories	Wireless Push Switch , Hand Scanner , Access Control	

* Specification are subjected to change for improvements

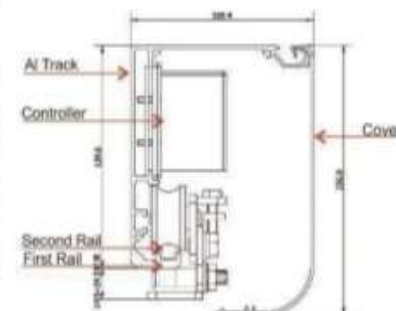

Cross Section of Aluminum Track

Sensor Door

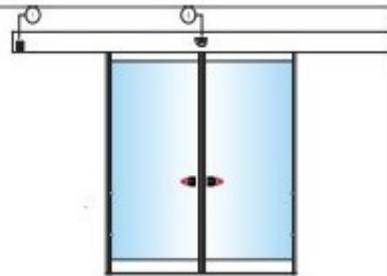

36V,85W Bruthless Motor



Boom Barrier



Various option in length available

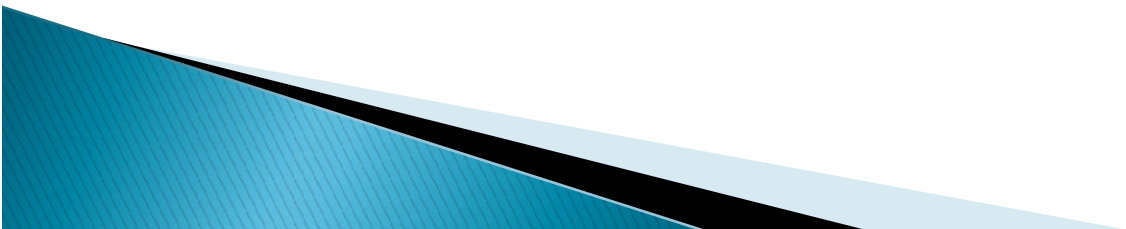

Swing Gate

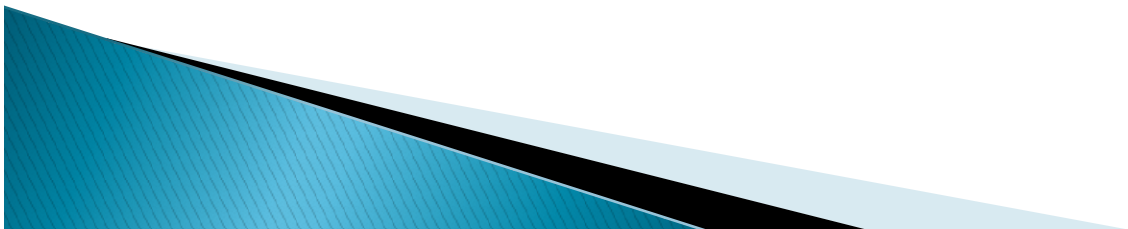

Sliding Gate

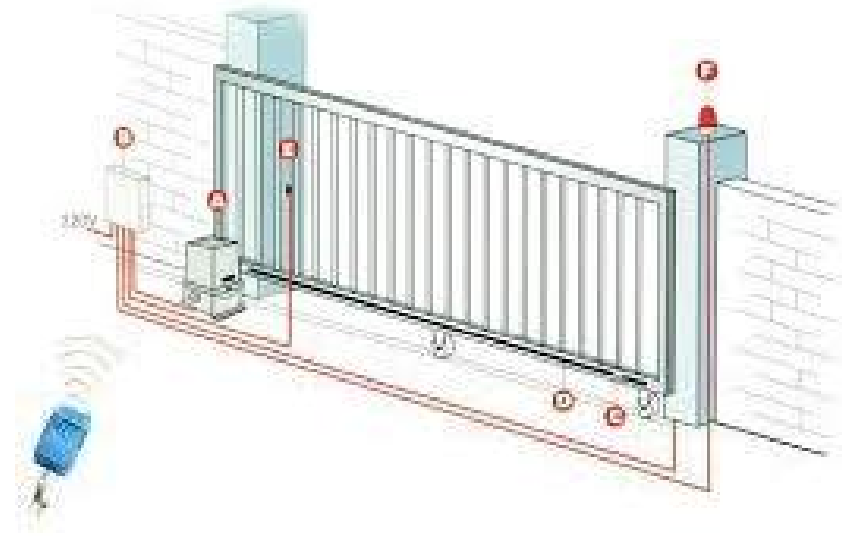

Various Exit Switches



No Touch

